

Model: SP-BTC22 one pair
2-Channel with 2*20W

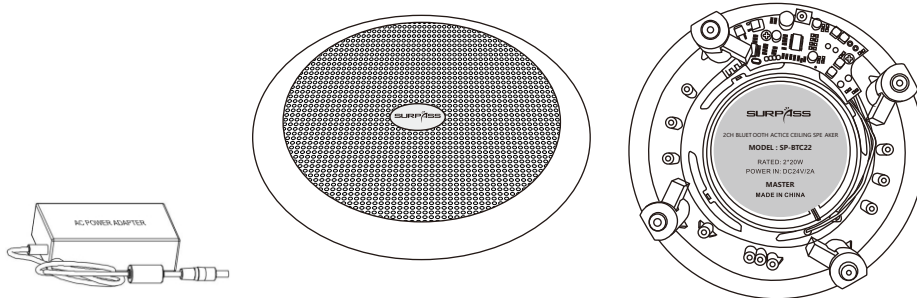

Contents:

Active master speaker SP-BTC20 1
 Passive slave speaker SP-CR520 1 (*Optional*)
 Manual 1
 Power adapter..... 1

Specifications:

Frequency Response: 90Hz-20KHz (±3dB) ;
 THD: <0.05% at 1kHz, 1/3 rated power;
 S/N: >78dB;
 Protocols: HFPV1.5, A2DPV1.2,AVRCPV1.4,
 HSP1.2, GAVDP1.2, IOP;
 Amplifier: 2*20W
 Speaker driver: woofer 5"*1 + tweeter 1"*1;
 Installation: in ceiling;
 Finish : white; baffle & Enclosure: ABS resin,
 grille & mounting hardware steel alloy;
 Power supply: DC24V/2A with AC adapter.
 Dimension: Φ203*80mm;
 Cutting hole: Φ170mm;
 Net weight: 1.25kg

Features:

- Solution of stereo wireless Bluetooth transmission, the adoption of BK8000L BEKEN chip module with high-quality sound quality and compatibility;
- DC24V/2A power supply with AC adapter;
- Bluetooth transmission distance 10 meters;
- Digital Class D amplifier with output 2*20W;
- 2-way coaxial system;
- Frame-mounted dog-ear hook providing secure, low-noise connections and easy installation;
- Attractive color ABS resin finish with white grille suits any decor.

Product Details:

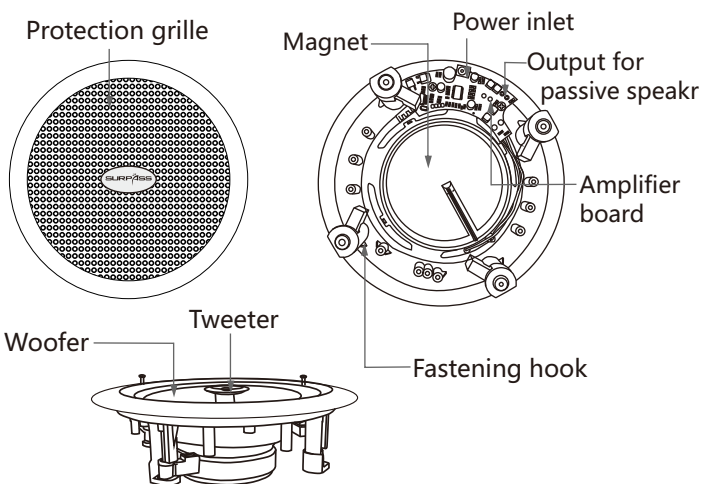

Connection:

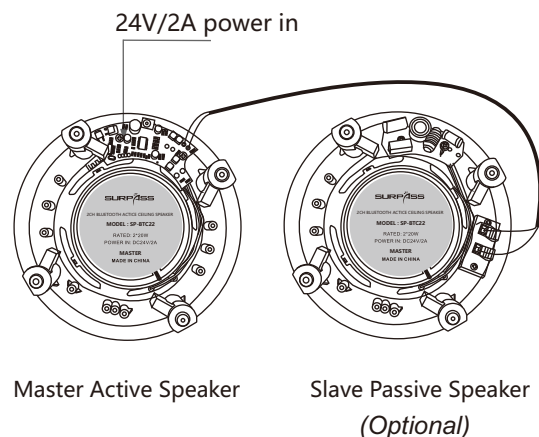

Installation:

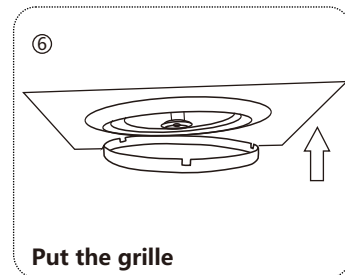
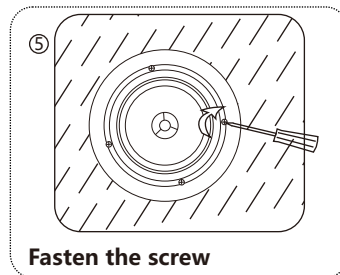
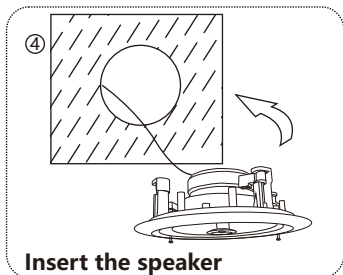
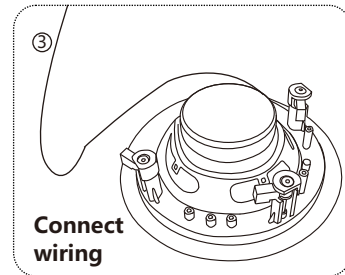
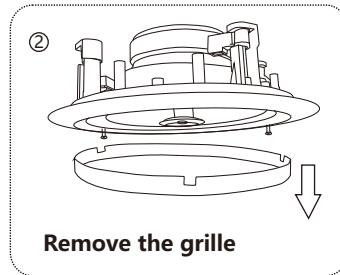
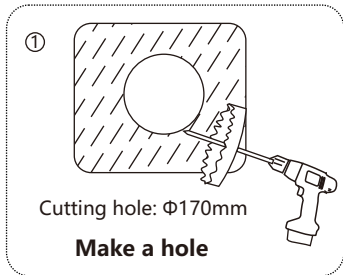

Bluetooth Operations:

*Note: The Bluetooth name of this speaker is **"BGM SYSTEM"**

In order to enjoy music from a Bluetooth device on this speaker, the Bluetooth device must first be paired with this speaker.

Once the Bluetooth device has been paired, it does not need to be paired

1. Activate the Bluetooth settings on your mobile device.



2. Select this unit **"BGM SYSTEM"** when its name appears in the list of devices displayed on the screen of your mobile device. Perform the connection with your mobile device close to the unit (about 1 m). At the end of the pairing, the name **"BGM SYSTEM"** appears on the paired list of your mobile device.

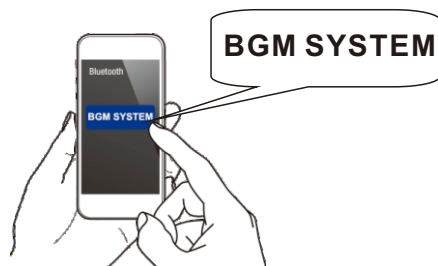

*Note: Enter **"1688"** when the password is requested on the screen of the your mobile device.

3. Play music using any app on your mobile device.

* The next time the input source is switched to Bluetooth, this speaker automatically connects to the last Bluetooth device that was connected.

